

Programmateur

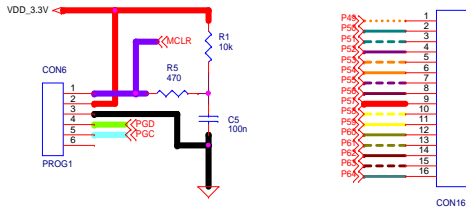

Processeur DSP

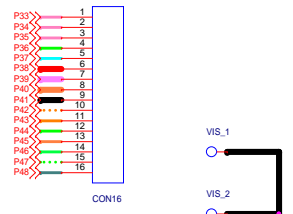
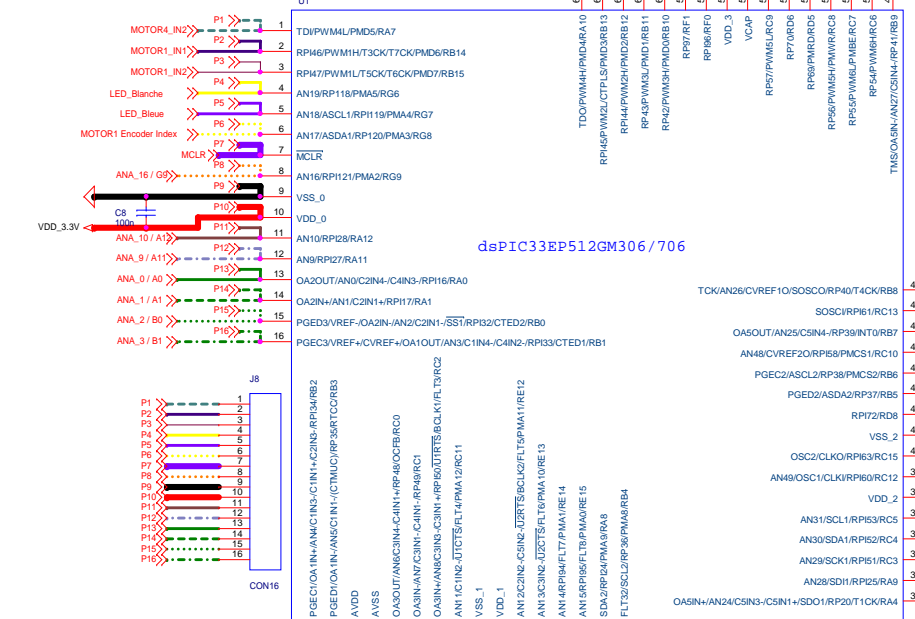

LEDs

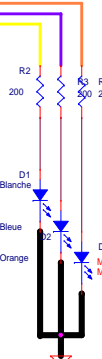

Encodeurs

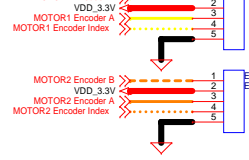

Alimentations

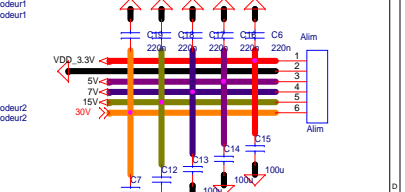

Hacheurs

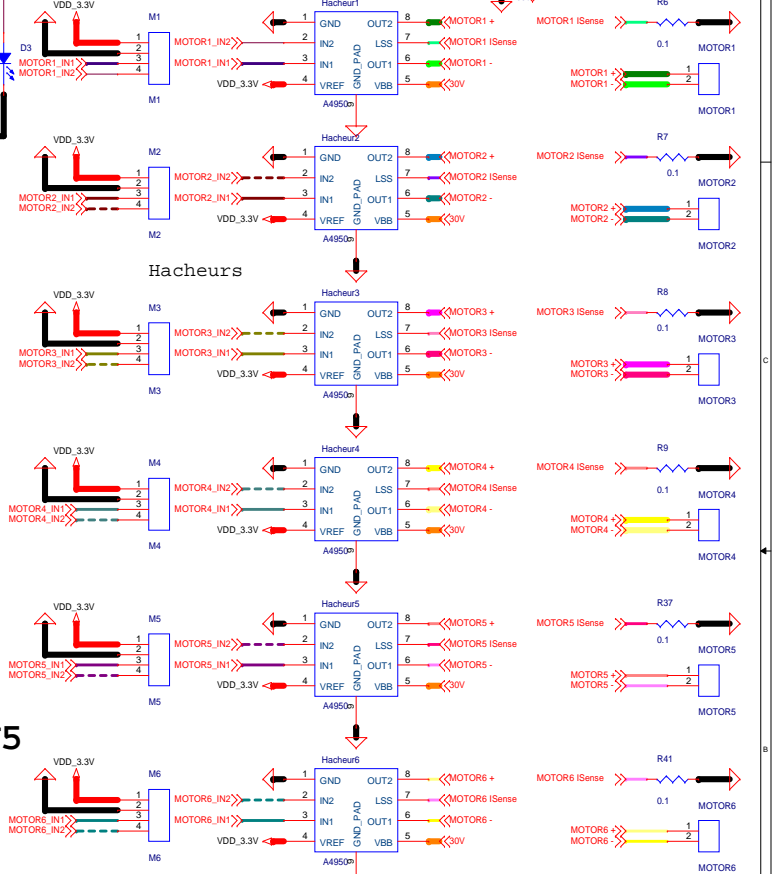

Carte Moteur V5 IUT de Toulon

Entrées-Sorties

Bus Série SPI I2C

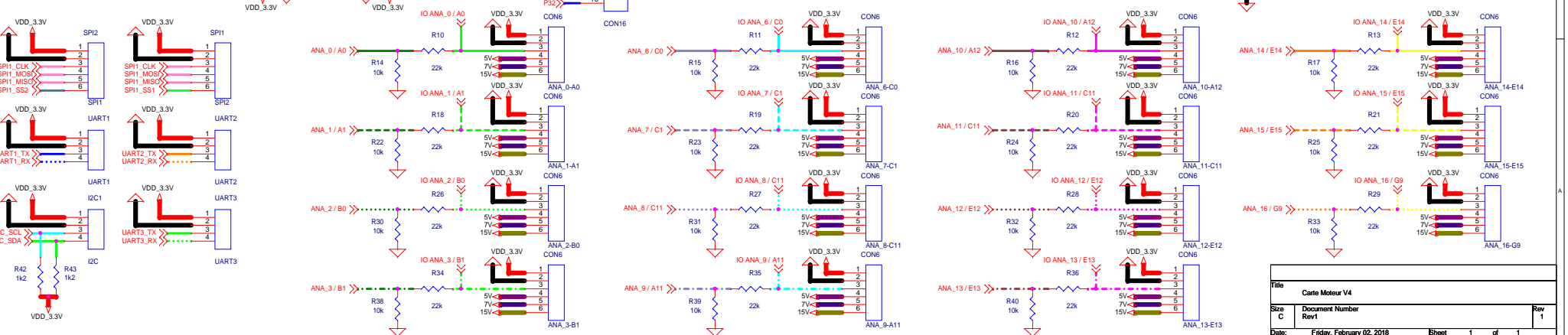

Title		Carte Moteur V4	
Size	C	Document Number	Rev1
Date:	Friday, February 02, 2018	Sheet	1 of 1